



### PRO DECK 200X100CM Black Hexa anti-slip Plywood

**NEW**

New PRO DECK 200X100CM is only 29 kg. Two longitudinal beams and a special profile design ensures full stability. Highest quality confirmed by TUV certificate which ensures maximum safety.

Product code ED-T-SCA03-2X1



## PRO DECK 200X100CM Black Hexa anti-slip Plywood

### Specification

dimensions	2,0 x 1,0 m (standard) Available dimensions - page 15
load bearing capacity	500 kg/m <sup>2</sup>
plywood	12 mm
weight	2 x 1 m - 29 kg

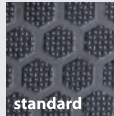
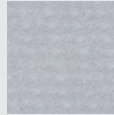
profile height	90 mm		
available colors	 standard black hexa	 black	 brown
	 gray	 wood	

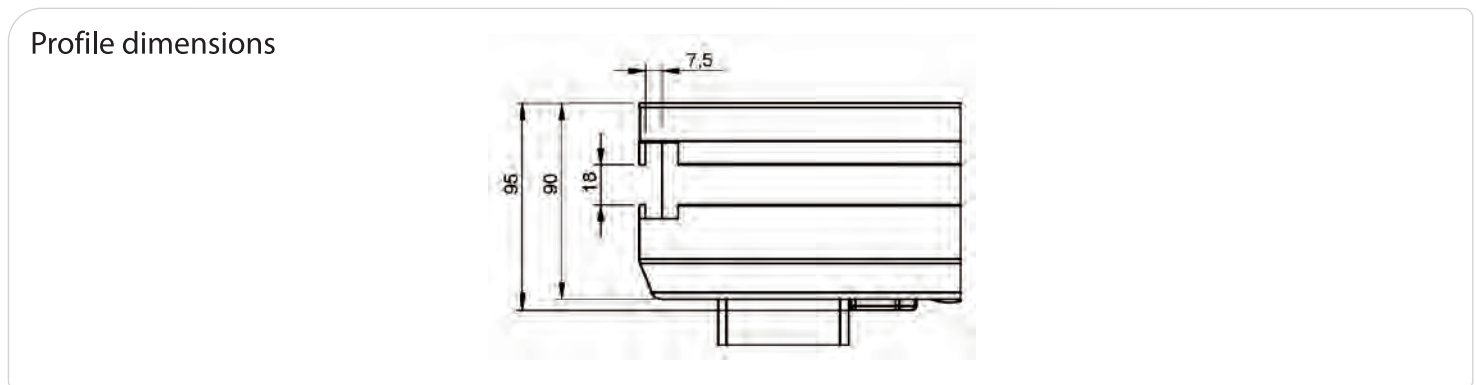
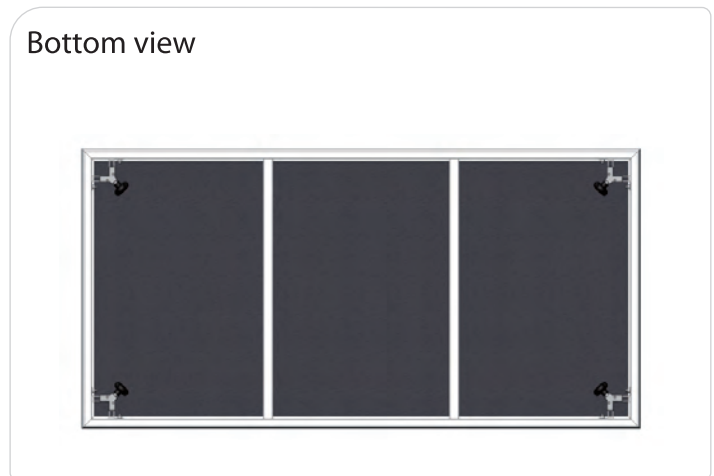
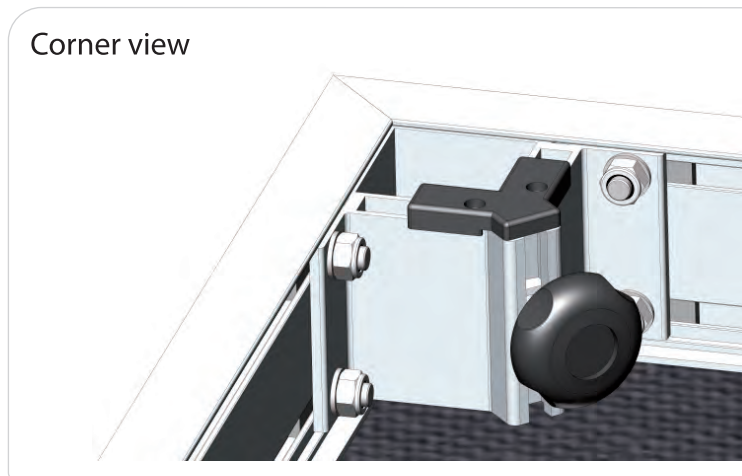

DECK TO DECK Clamping CLAMP



DECK TO DECK Clamping CLAMP

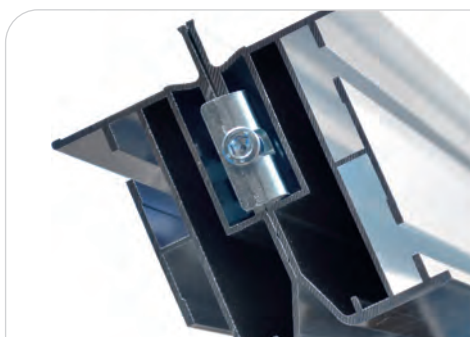

DECK TO DECK CLAMP



# STAGE PLATFORMS

## Platform dimensions

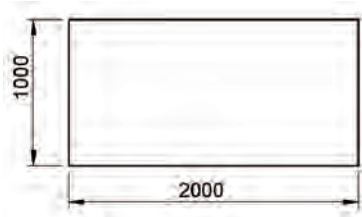

Weight  
PRO DECK 200X100CM - 32 kg  
code: ED-T-SCA03-2X1

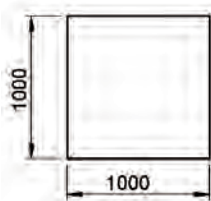

Weight  
PRO DECK 100X100CM – 18,3kg  
code: ED-T-SCA03-1X1

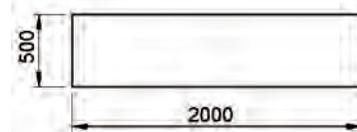

Weight  
PRO DECK 200X050CM - 18,3kg  
code: ED-T-SCA03-2X05

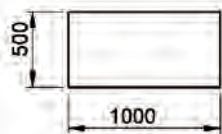

Weight  
PRO DECK 100X050CM - 11,8kg  
code: ED-T-SCA03-1X05

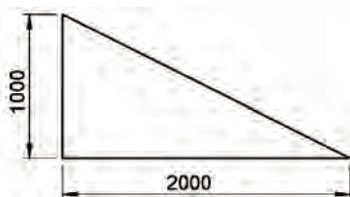

Weight  
ED-T-SCA 03 - 18,6kg

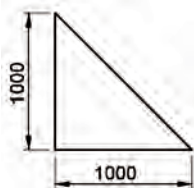
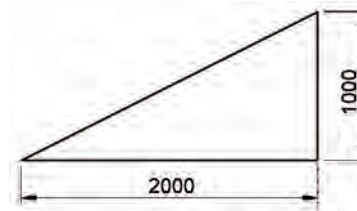

Weight  
ED-T-SCA 03 - 11,5kg

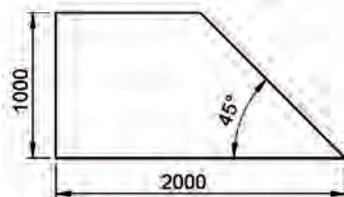

Weight varies depending on the angle  
Angle - in the range of 45 to 90 degrees

